

WP-6 1X8 Clear

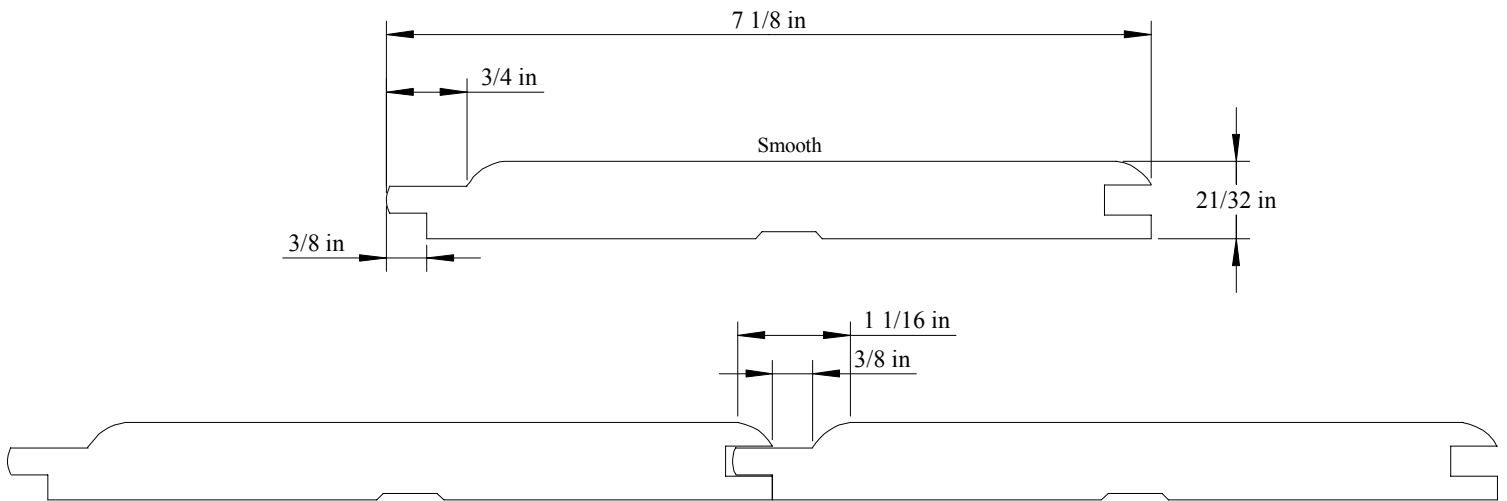

Edmund Allen Lumber

Date: _____

I agree that this drawing and the dimensions provided are correct and I give permission to Edmund Allen Lumber to proceed with this job. This material has been special ordered and is not returnable.

Signature: _____

